

M_122 Decor

360 ml / h: 93 mm / Ø 87 mm

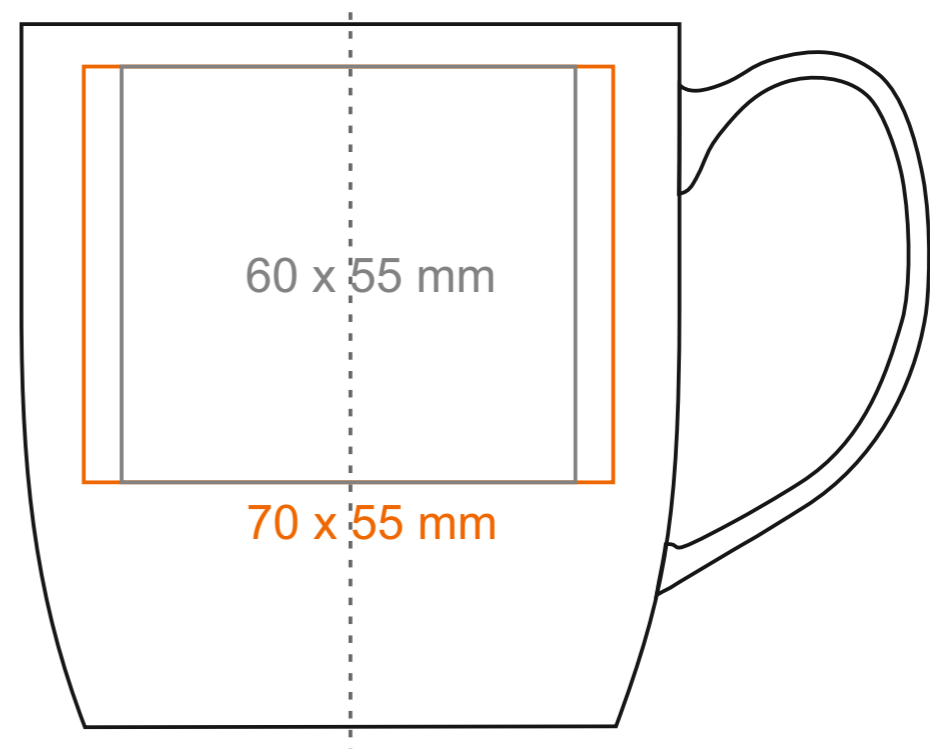
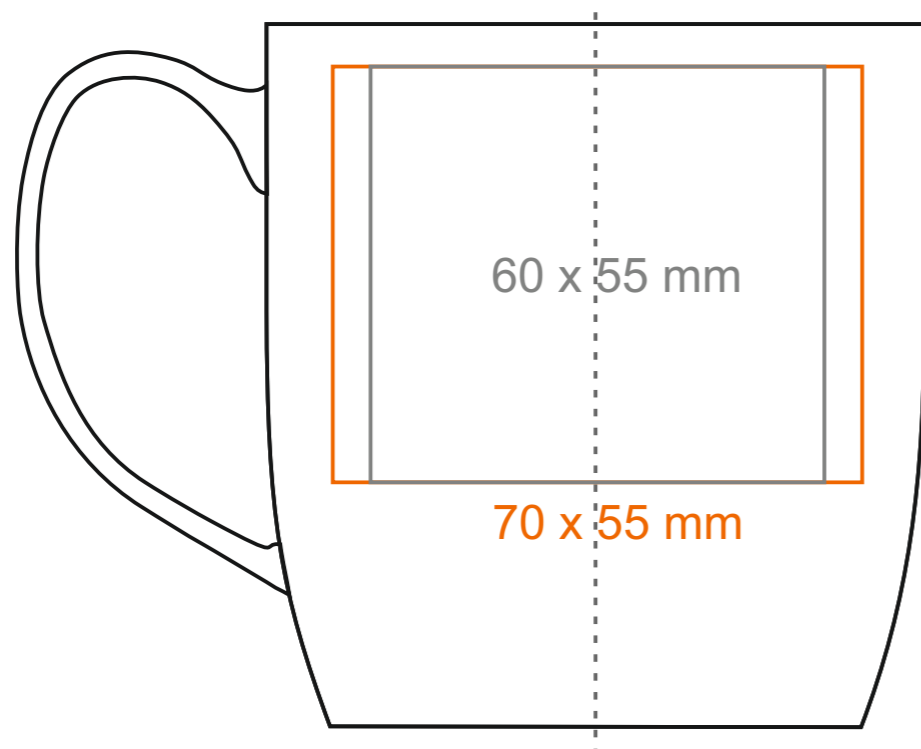
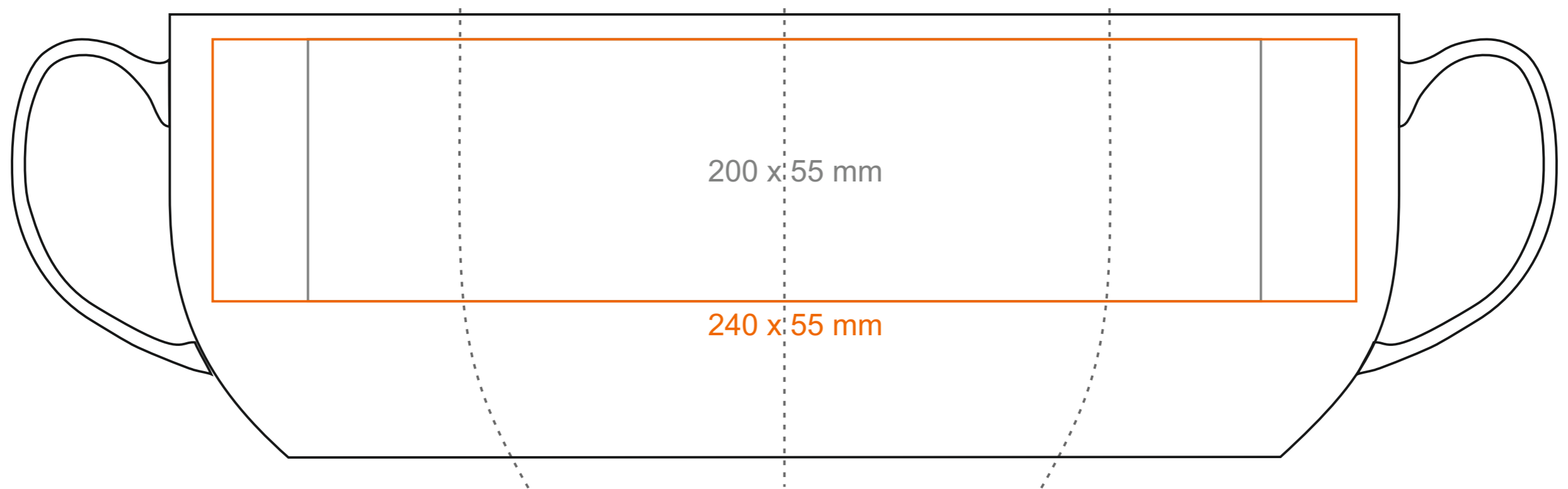

Stampa sul manico
 Stampa interna
 Stampa sul fondo interno
 Stampa sul fondo esterno

- 50 x 10 mm
 - 50 x 20 mm
 - Ø 40 mm
 - Ø 50 mm

*Nel caso di progetti per la stampa a transfer oltre l'area di stampa standard, si prega di contattare il nostro ufficio commerciale.

[Come preparare il materiale di stampa?](#)

significato

— Stampa a Transfer
 — Sensitive Touch
 — Stampa Diretta